

BE-150-EA

ENFRIADOR DE BOTELLAS

CARACTERÍSTICAS

- Exterior en acero plastificado blanco.
- Respaldo en chapa de acero galvanizado.
- Interior en acero galvanizado.
- Puertas inox deslizantes sobre bastidor.
- Encimera de acero inoxidable.
- Separadores interiores en alambre de acero plastificado.
- Unidad condensadora ventilada y extraíble
- Evaporador estático.
- Aislamiento de poliuretano inyectado, densidad 40 kg/m³, cero efectos ODP y GWP.
- Control mecánico de temperature.



Largo (mm)	Fondo (mm)	Alto (mm)	Capacidad (L)	Potencia frigorífica (W)	Rango	Clase climática	Refrigerante
1500	550	850	420	255	+2°C +8°C	S (40°C 40%HR)	R-290

Características técnicas y constructivas sujetas a variación sin previo aviso, todas las fotos deben ser consideradas como una referencia

BE-150-EA

ENFRIADOR DE BOTELLAS

Control de temperatura	Digital
Evaporador	Bloque aleteado epoxi
Condensador	Bloque aleteado
Voltaje / Frecuencia	230V / 50Hz
Potencia nominal	155 W
Aislante térmico	Poliuretano, densidad 40 kg/m ³ , cero ODP y GWP
Agente espumante	HFO
Espesor aislante costado	40 mm
Exterior	Acero plastificado blanco
Respaldo exterior	Acero galvanizado
Interior	Acero galvanizado
Luz	No
Número de estantes	2
Dimensiones estante (W x D)	-

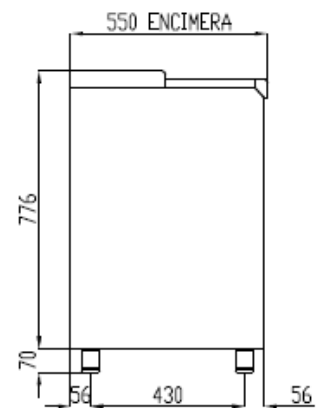
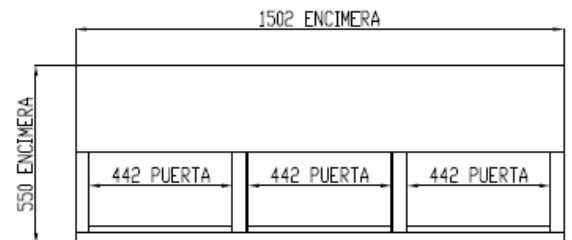
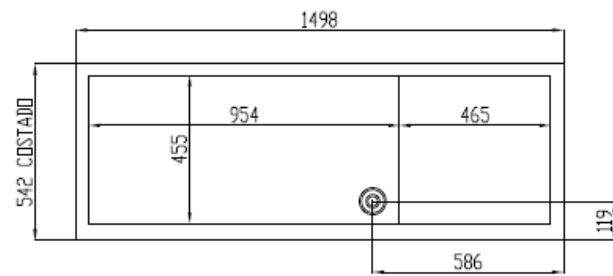
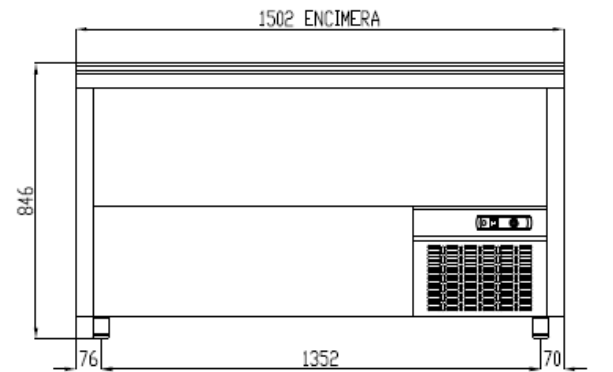

Características técnicas y constructivas sujetas a variación sin previo aviso, todas las fotos deben ser consideradas como una referencia

BE-150-EA

CHEST BOTTLE COOLER

CARACTERÍSTICAS

- Plasticized exterior.
- Rear side galvanized panel.
- Interior in galvanized steel.
- Stainless steel sliding doors.
- Stainless steel worktop.
- Plasticized steel wire internal dividers.
- Removable and fan assisted condenser unit.
- Static evaporator.
- 40 Kg/m³ density polyurethane insulation, zero ODP and GWP.
- Mechanic control of temperature.



Largo (mm)	Fondo (mm)	Alto (mm)	Capacidad (L)	Potencia frigorífica (W)	Rango	Clase climática	Refrigerante
1500	550	850	420	255	+2°C +8°C	S (40°C 40%HR)	R-290

We reserve the right to change specifications without prior notice, all photos must be considered as a reference

BE-150-EA

CHEST BOTTLE COOLER

Temperature control	Digital
Evaporator	Bloque aleteado epoxi
Condenser	Bloque aleteado
Voltage / Frequency	230V / 50Hz
Nominal power	155 W
Insulation material	Poliuretano, densidad 40 kg/m ³ , cero ODP y GWP
Foaming agent	HFO
Insulation thickness	40 mm
Exterior	Plasticized exterior
Exterior rear side	Galvanized steel
Interior	Galvanized interior
Lighting	No
Number of shelves supplied	2
Shelf dimensions (W x D)	-

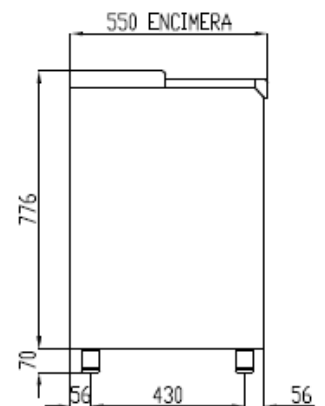
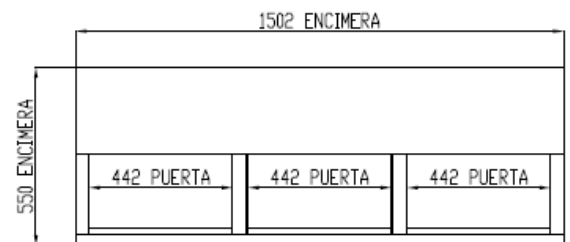
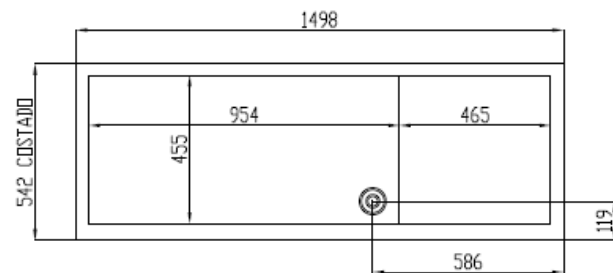
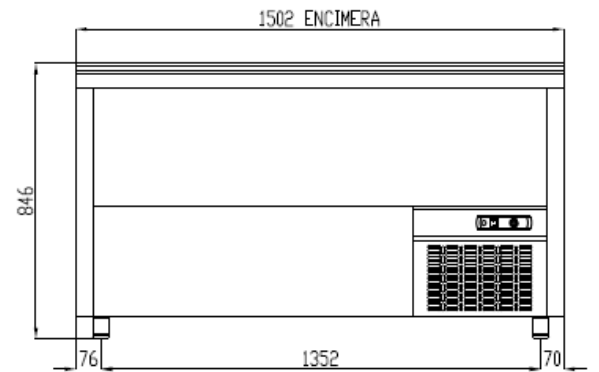

We reserve the right to change specifications without prior notice, all photos must be considered as a reference