

CAJÓN FMR 1/2

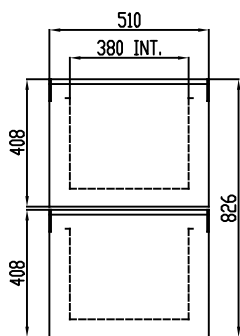

CAJONERA
1/2 + 1/2

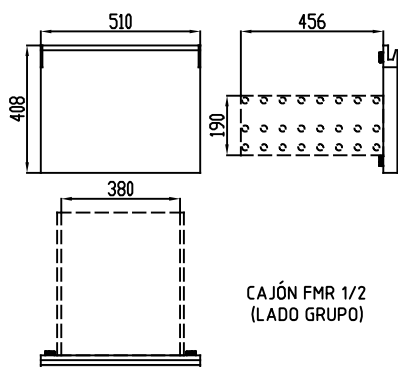
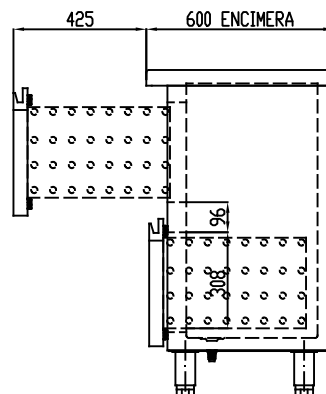
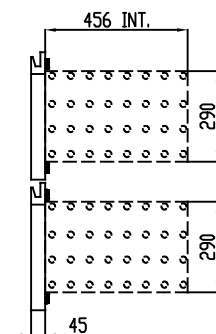

CAJÓN FMR 1/2
(LADO GRUPO)

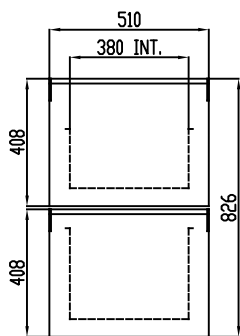

CAJONERA LADO GRUPO
1/2 + 1/2

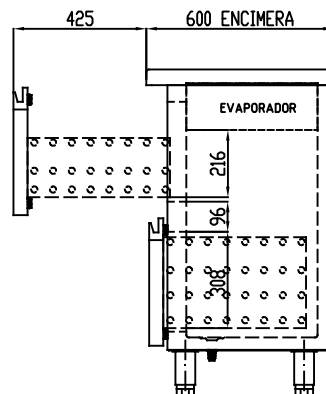
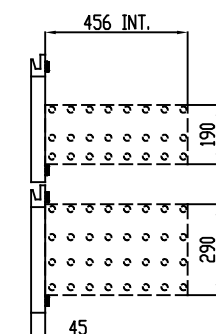

MESAS SNACK REFRIGERACIÓN/CONGELACIÓN

COD. PIEZA: X

COTAS SIN TOLERANCIA DIN 7168-f

Material: .

SUSTITUYE A: .

Acabado: .

SUSTITUIDO POR: .

ANGULAR	GRADO TOLERANCIA	FINO	MEDIO	GRUESO
	HASTA 10 mm		±1°	
MAS DE 10 A 50 mm		±30'		±50'
MAS DE 50 A 120 mm		±20'		±25'
MAS DE 120 A 400 mm		±10'		±15'
MAS DE 400 mm		±5'		±10'

COMÚN A	MODELO	Ud.	MODELO	Ud.	MODELO	Ud.	MODELO	Ud.	MODELO

LINEAL	GRADO TOLERANCIA	FINO	MEDIO	GRUESO
	HASTA 3 mm		±0,05	±0,10
MAS DE 3 A 6 mm		±0,05	±0,10	±0,20
MAS DE 6 A 30 mm		±0,10	±0,20	±0,50
MAS DE 30 A 120 mm		±0,15	±0,30	±0,80
MAS DE 120 A 400 mm		±0,20	±0,50	±1,20
MAS DE 400 A 1000 mm		±0,30	±0,80	±2,00
MAS DE 1000 A 2000 mm		±0,50	±1,20	±3,00

A4	Nombre	Fecha
Dibujado	RGL	01-06-2023
Modificado	.	.
Escala	CAJONES MESAS FRENTE MOSTRADOR S-LINE KIT CAJONES GUÍAS FULTERER	



Código máquina:

CODIGO