

CAJÓN PASTELERA 1/2

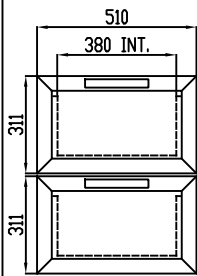

CAJONERA
1/2 + 1/2

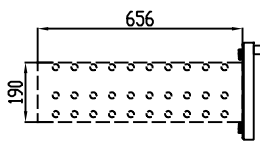
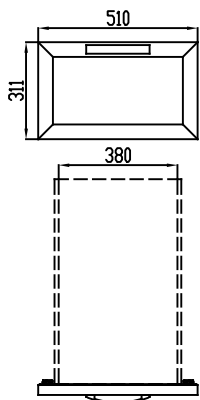
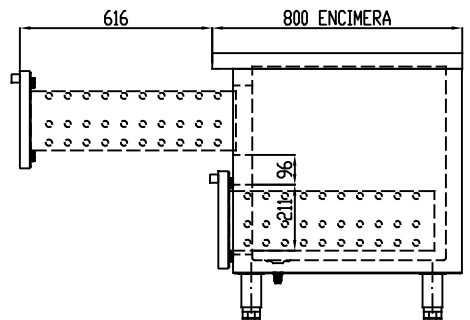
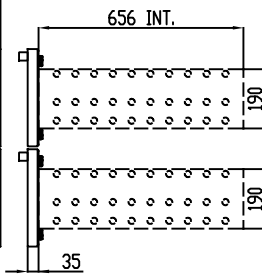

CAJÓN PASTELERA 1/2
(LADO GRUPO)

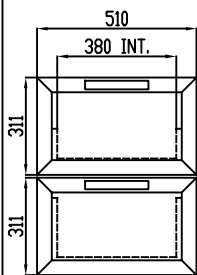
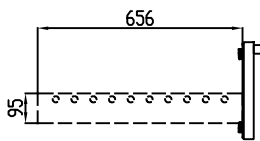

CAJONERA LADO GRUPO
1/2 + 1/2

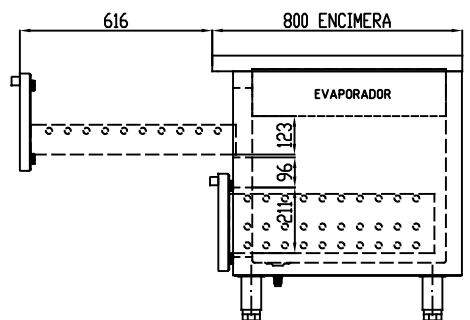
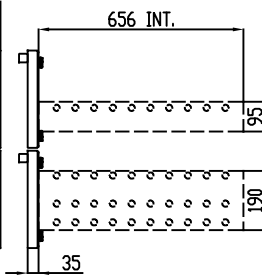

MESAS PASTELERAS REFRIGERACIÓN/CONGELACIÓN

COD. PIEZA: X

COTAS SIN TOLERANCIA DIN 7168-f

Material: .

SUSTITUYE A: .

Acabado: .

SUSTITUIDO POR: .

	GRADO TOLERANCIA			
	FINO	MEDIO	GRUESO	
ANGULAR	HASTA 10 mm	±1°	±1° 30'	
	MAS DE 10 A 50 mm	±30'	±50'	
	MAS DE 50 A 120 mm	±20'	±25'	
	MAS DE 120 A 400 mm	±10'	±15'	
	MAS DE 400 mm	±5'	±10'	
LINEAL	HASTA 3 mm	±0,05	±0,10	±0,15
	MAS DE 3 A 6 mm	±0,05	±0,10	±0,20
	MAS DE 6 A 30 mm	±0,10	±0,20	±0,50
	MAS DE 30 A 120 mm	±0,15	±0,30	±0,80
	MAS DE 120 A 400 mm	±0,20	±0,50	±1,20
	MAS DE 400 A 1000 mm	±0,30	±0,80	±2,00
	MAS DE 1000 A 2000 mm	±0,50	±1,20	±3,00

COMÚN A	MODELO	Ud.	MODELO	Ud.	MODELO	Ud.	MODELO	Ud.	MODELO

A4	Nombre	Fecha
Dibujado	RGL	01-06-2023
Modificado		



Escala

CAJONES MESAS PASTELERAS CRISTAL
KIT CAJONES GUÍAS FULTERER

Código máquina:
CODIGO