

BNP-120

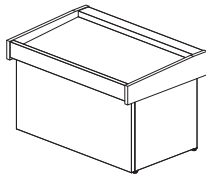

BNP-170

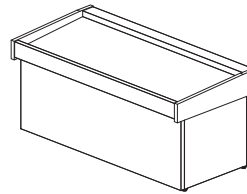

BNP-220

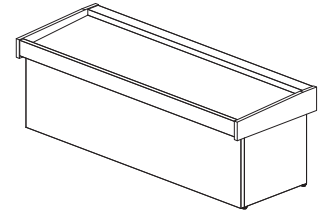

BNP-270

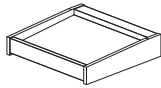

BNP-120-S

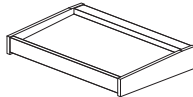

BNP-170-S

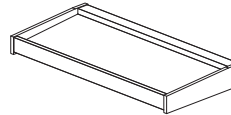

BNP-220-S

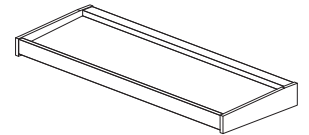

BNP-270-S

ref.	largo length (mm)	alto height (mm)	fondo depth (mm)	exposición display (m ²)
BNP-120	1200	1000 / 925	950	0,96
BNP-170	1700	1000 / 925	950	1,40
BNP-220	2200	1000 / 925	950	1,84
BNP-270	2700	1000 / 925	950	2,30
BNP-120-S	1200	95	950	0,96
BNP-170-S	1700	95	950	1,40
BNP-220-S	2200	95	950	1,84
BNP-270-S	2700	95	950	2,30

Características técnicas y constructivas sujetas a variación sin previo aviso.

We reserve the right to change specifications without prior notice.

SUPERMARKET

- Mostrador de pescado neutro, sin evaporador ni equipo frigorífico, preparado para la exposición de pescado sobre lecho de escamas de hielo.
- Chasis construido con tubo de acero inoxidable, AISI-304, con ruedas (2 con freno y 2 sin freno)
- Bandeja de exposición de acero inoxidable AISI-304, hermética.
- Aislamiento de poliuretano inyectado, densidad 40 Kg/m³, cero efectos ODP y GWP
- Sistema de desagüe
- BNP: chasis, placa neutra
- BNP-S: sin chasis, placa neutra

- Supermarket fish counter, without evaporator and condenser unit, ready to show the fresh product on ice.
- AISI-304 tubular chassis
- AISI-304 welded and sealed structure, hermetic to avoid water leaks
- Aislamiento de poliuretano inyectado, densidad 40 Kg/m³, cero efectos ODP y GWP
- Draininig system
- BNP: chassis, no refrigerated tray exhibition
- BNP-S: no chassis, no refrigerated tray exhibition

Se recomienda canalizar el desagüe hasta tubería del sistema de drenado de aguas

It is recommended to connect the water outlet drain with an outer pipe

OPCIONES - OPTIONS **120** **170** **220** **270**

perímetro acristalado *perimetral glass*

largos especiales *customized lengths*

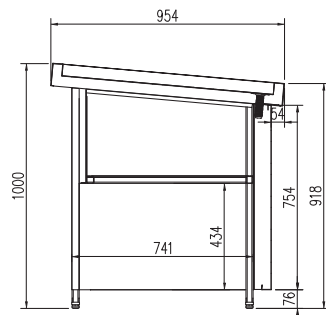
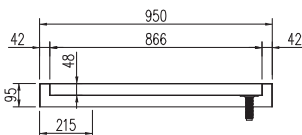

BNP-120